

Metal Wardrobe

Owner's Manual/
Instruction for Assembly Model:452.001

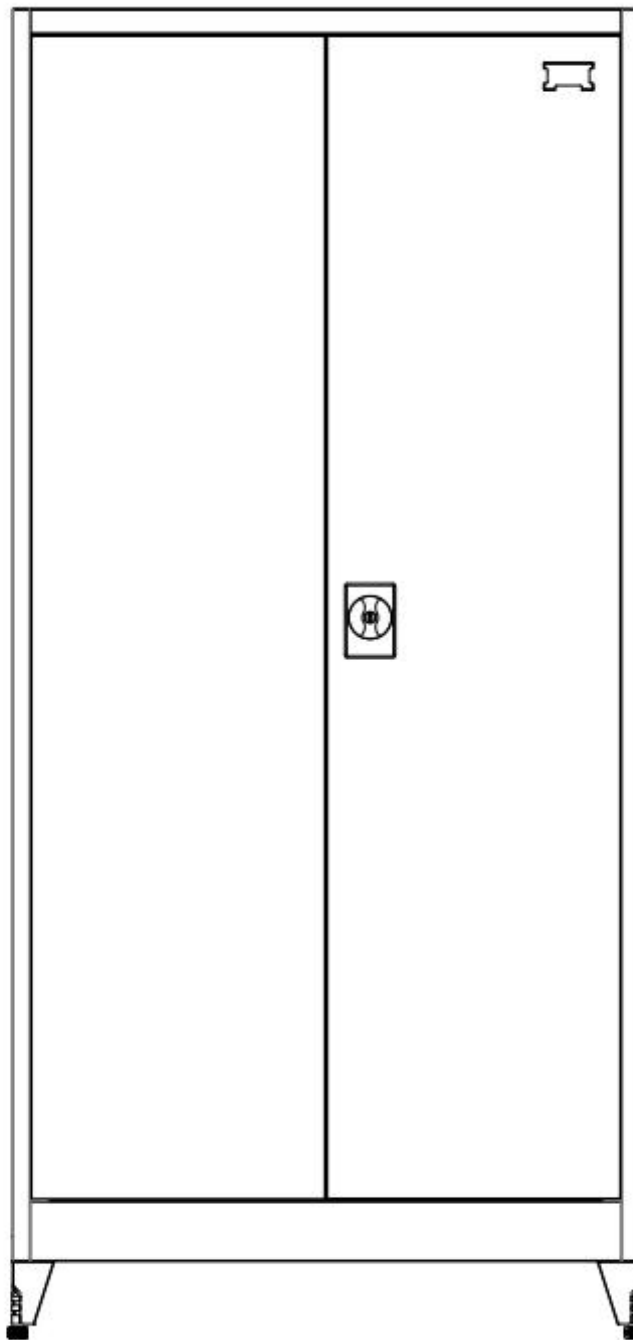

Size of Model:452.001

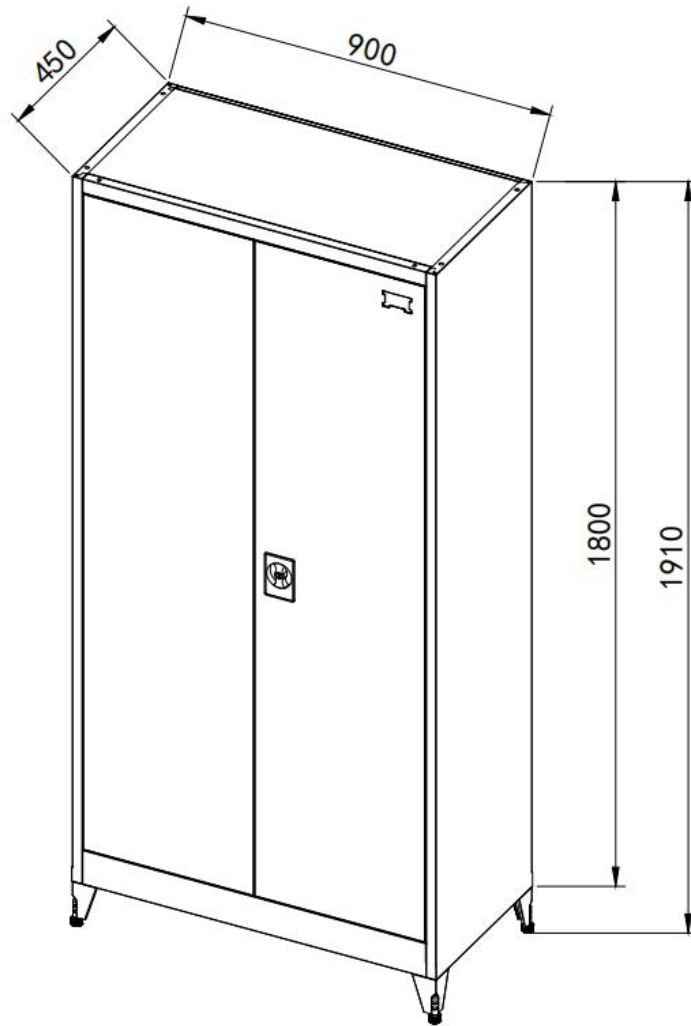

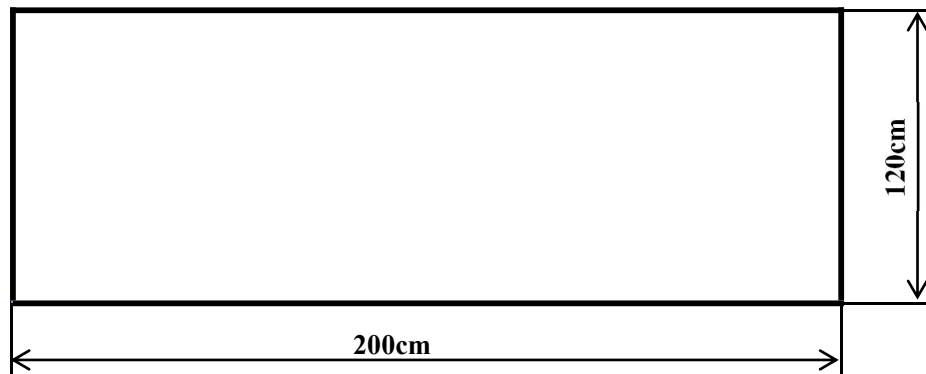

Area of installation requirement:

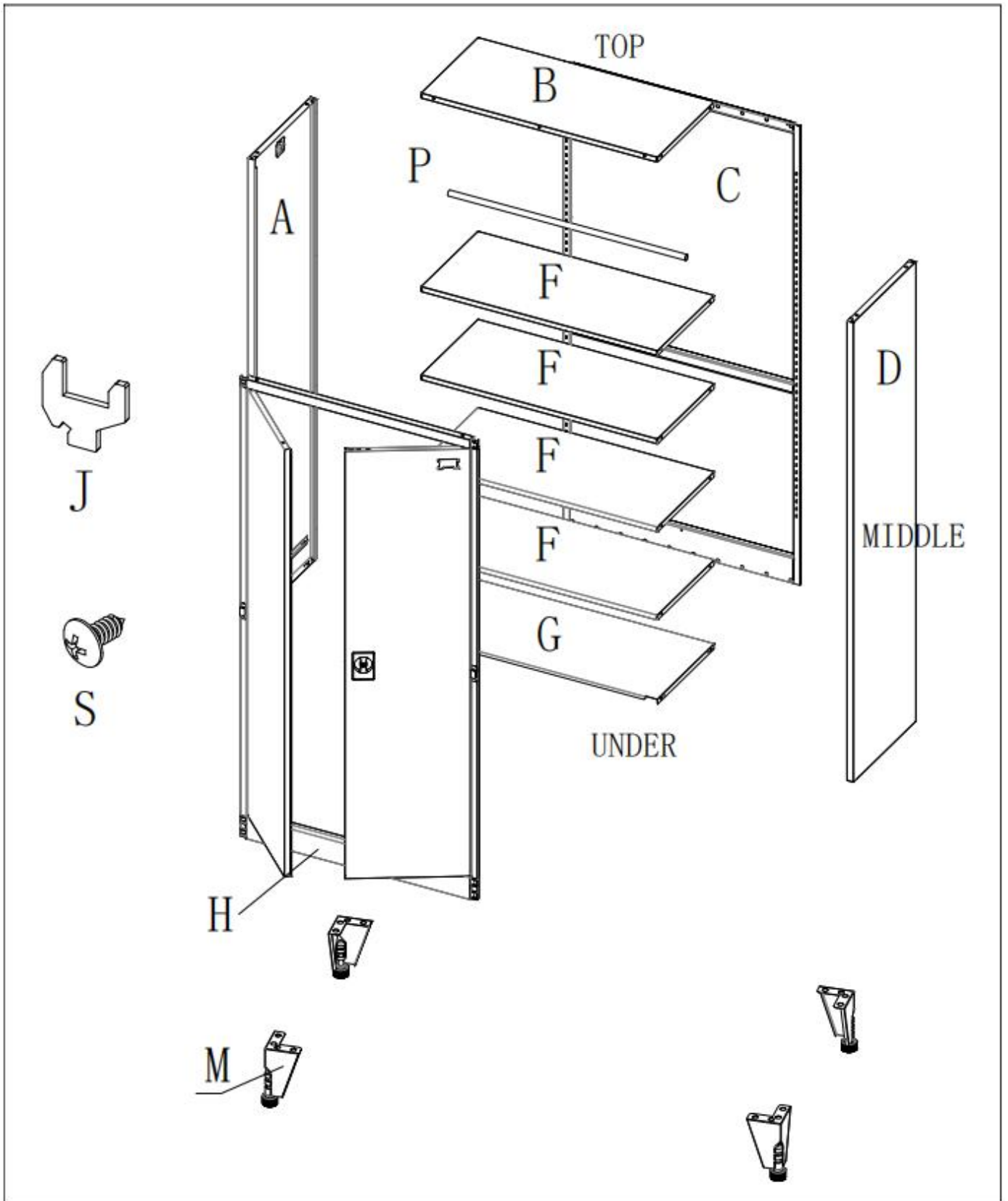

Explosive View:



Bill of Material:

No.	Size(mm)	Quantity(pc)
TOP		
B	410*897	x1
MIDDLE		
A	450*1800	x1
D	450*1800	x1
C	898*1798	x1
H	898*1800	x1
P	900	x1
F	409*897	x4
UNDER		
G	414*897	x1
M	60*60*110	x4
ANNEX		
J		x16
S		x31

