

Metal Wardrobe

Owner's Manual/
Instruction for Assembly Model:452.012

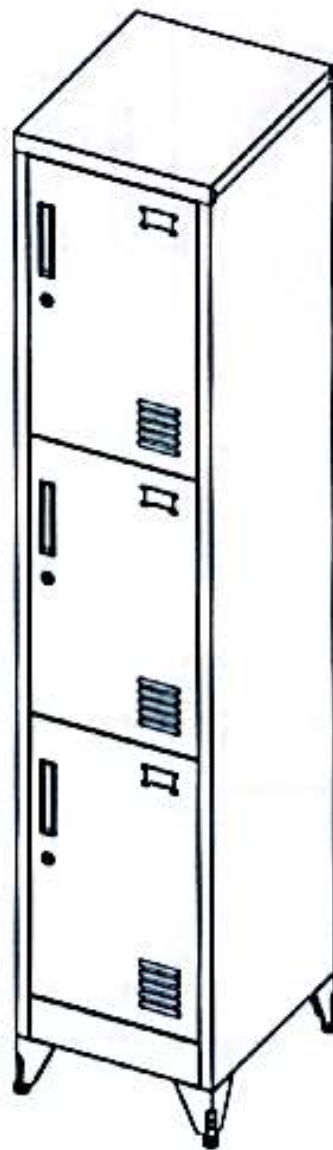

①

Size of Model:452.012

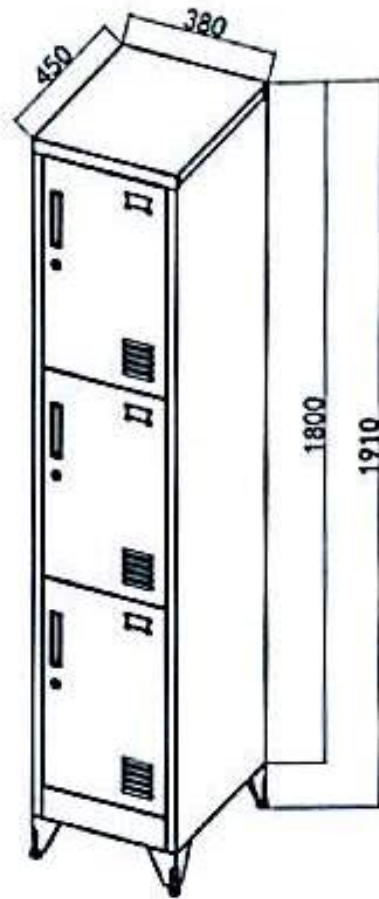

Area of installation requirement:

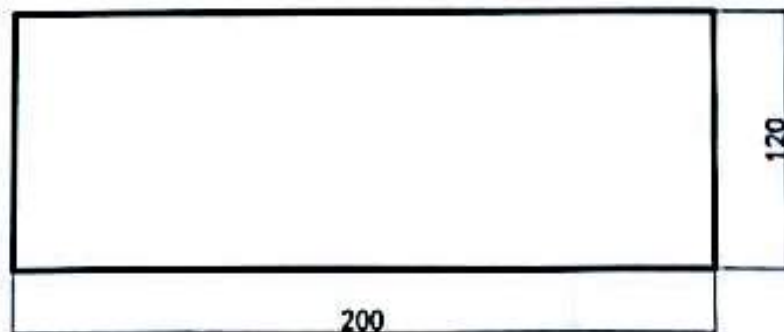

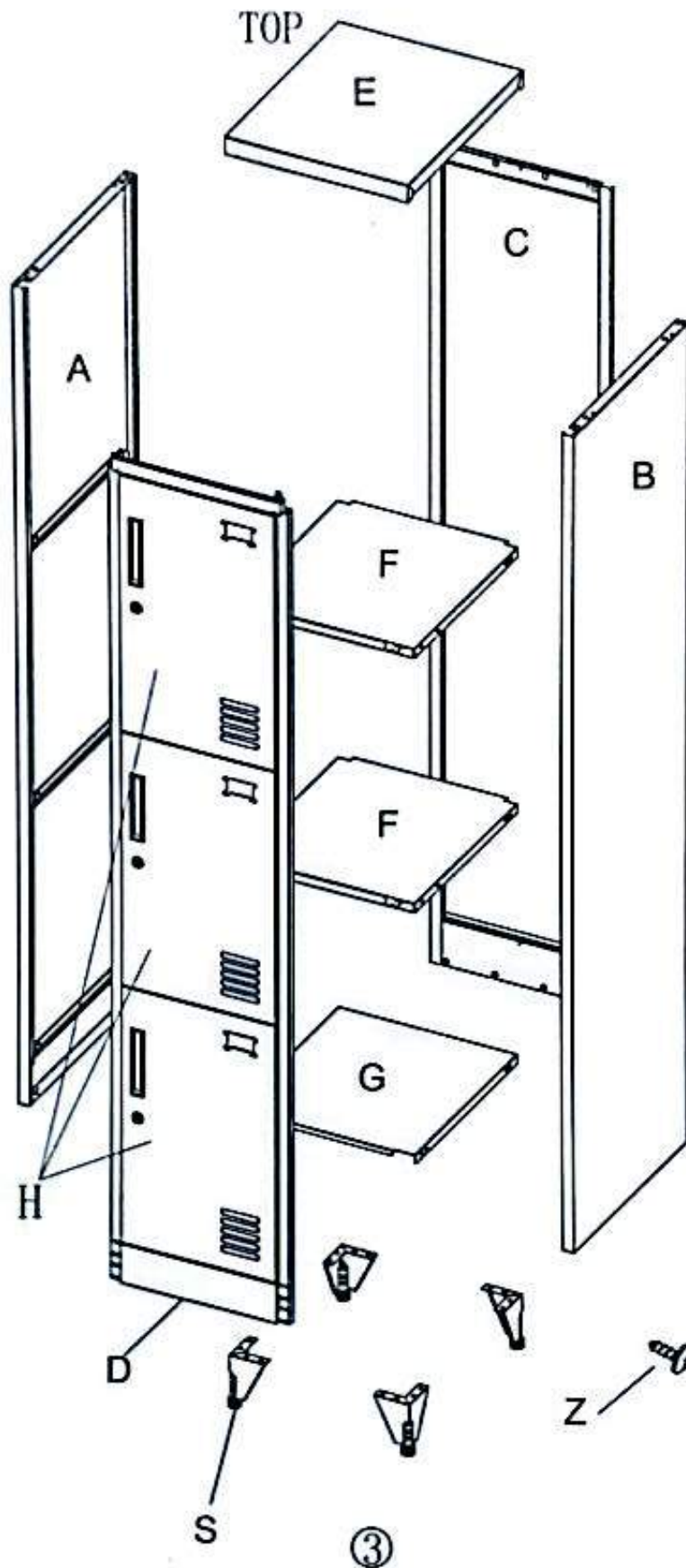

②

Explosive View:



Bill of Material:

No.	Size(mm)	Quantity(pc)
	TOP	
E	451.5*382	x1
	MIDDLE	
A	450*1770	x1
B	450*1770	x1
C	378*1768	x1
D	378*1799	x1
F	422*378.5	x2
G	414*377	x1
	UNDER	
H	556.5*327	x3
S	75*75*110	x4
	ANNEX	
Z		x29
X		x3
Y		x3

1

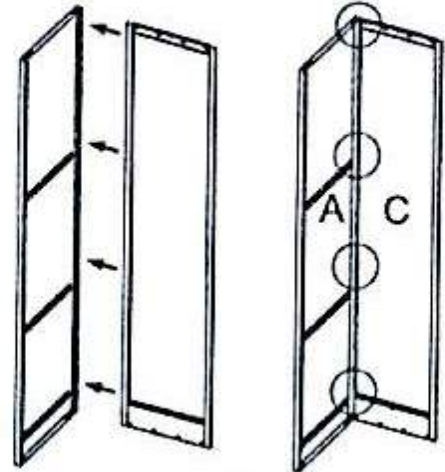
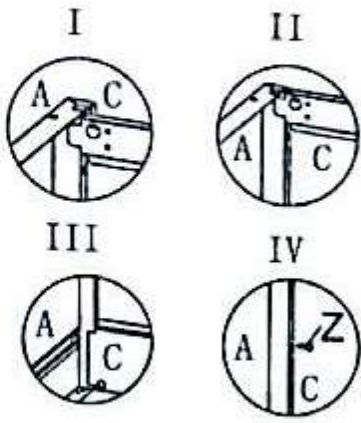

2

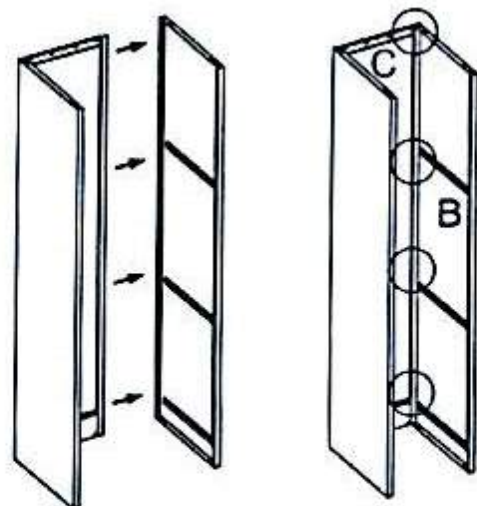
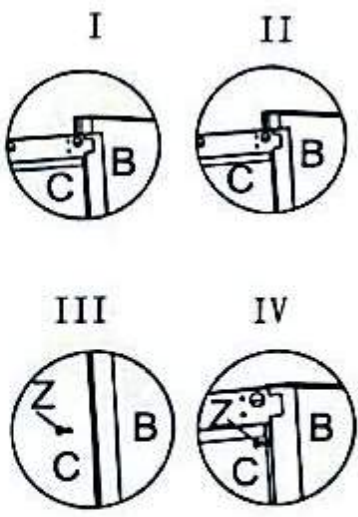

3

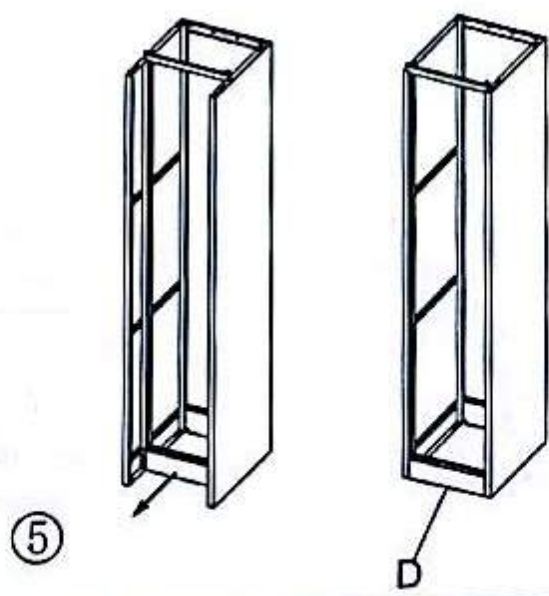
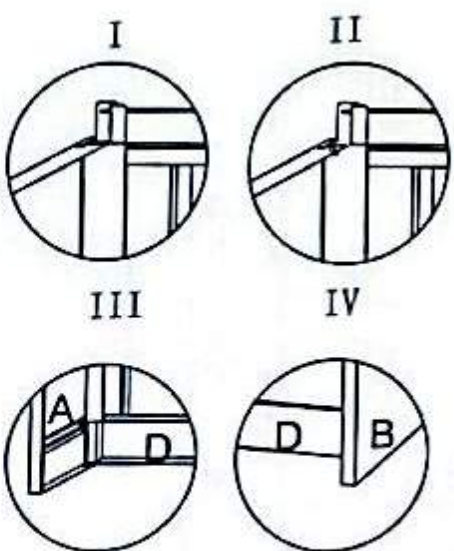

4

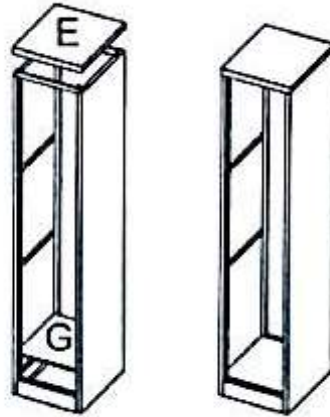
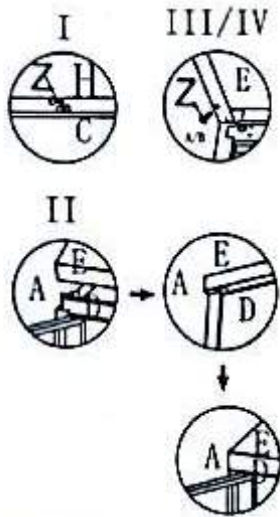

5

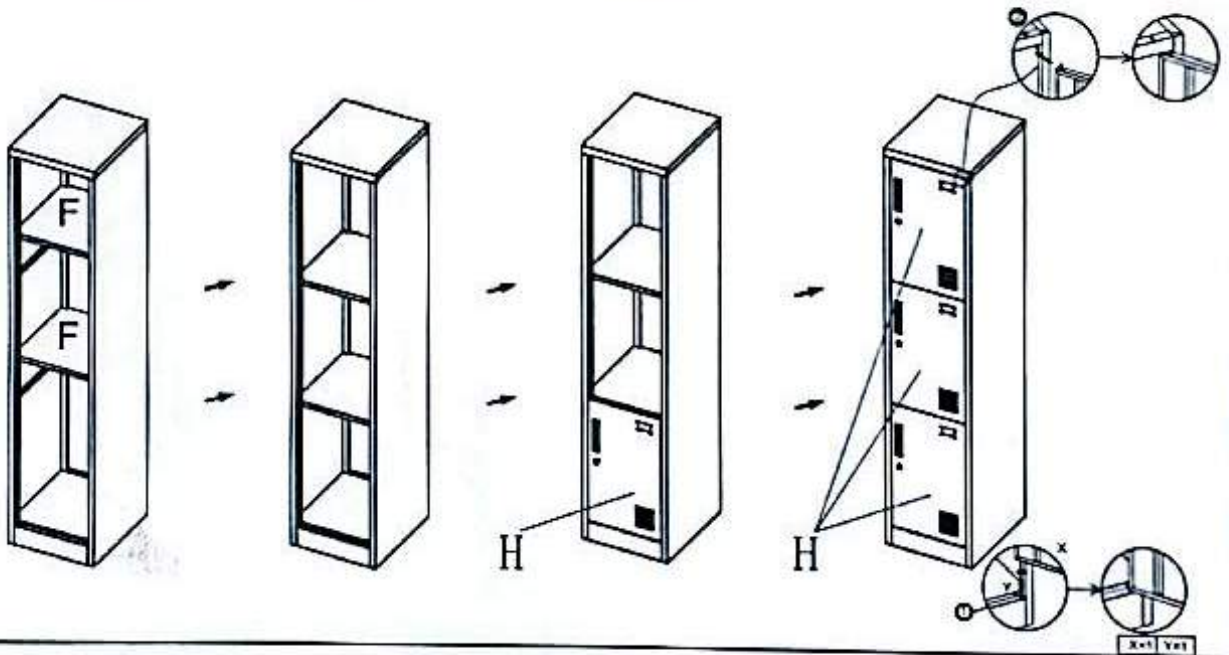

6

